

Code	T148
Input Voltage	DC42 215MA
Power(Watts)	9W
Lumen	620.8lm
Lamp holder	Ceramic PCB
Light Source	Bridgelux V6 HD
Beam Angle	30°
Color Temperature	3000K
CRI ≥	80
IP level	IP20
Main Material	Brass
Wire connection way	Track Adaptor
Class	<input type="checkbox"/> I <input type="checkbox"/> II <input checked="" type="checkbox"/> III
Certificates	CE . ROHS
Dimmable	Optional

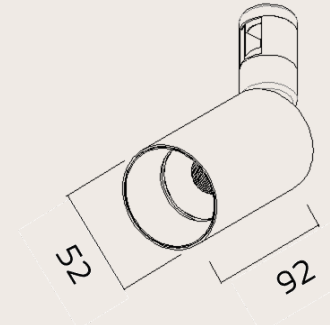

Optic Data

Luminous Intensity Distribution Curve

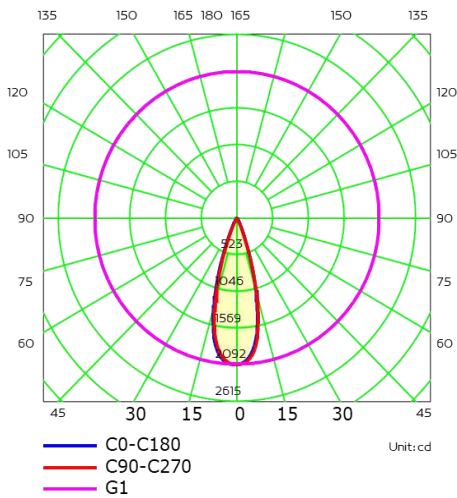

AAI Figure

